

Material	Schwerer Stahl
Oberfläche	verzinkt Chem. geschwärzt Stößel
Im Lieferumfang	M10x50 mm Spindeln Halterung
Max. Haltekraft	400 daN
Gewicht	0.8 kg
Hub	67 mm
Spanndruck	250 daN

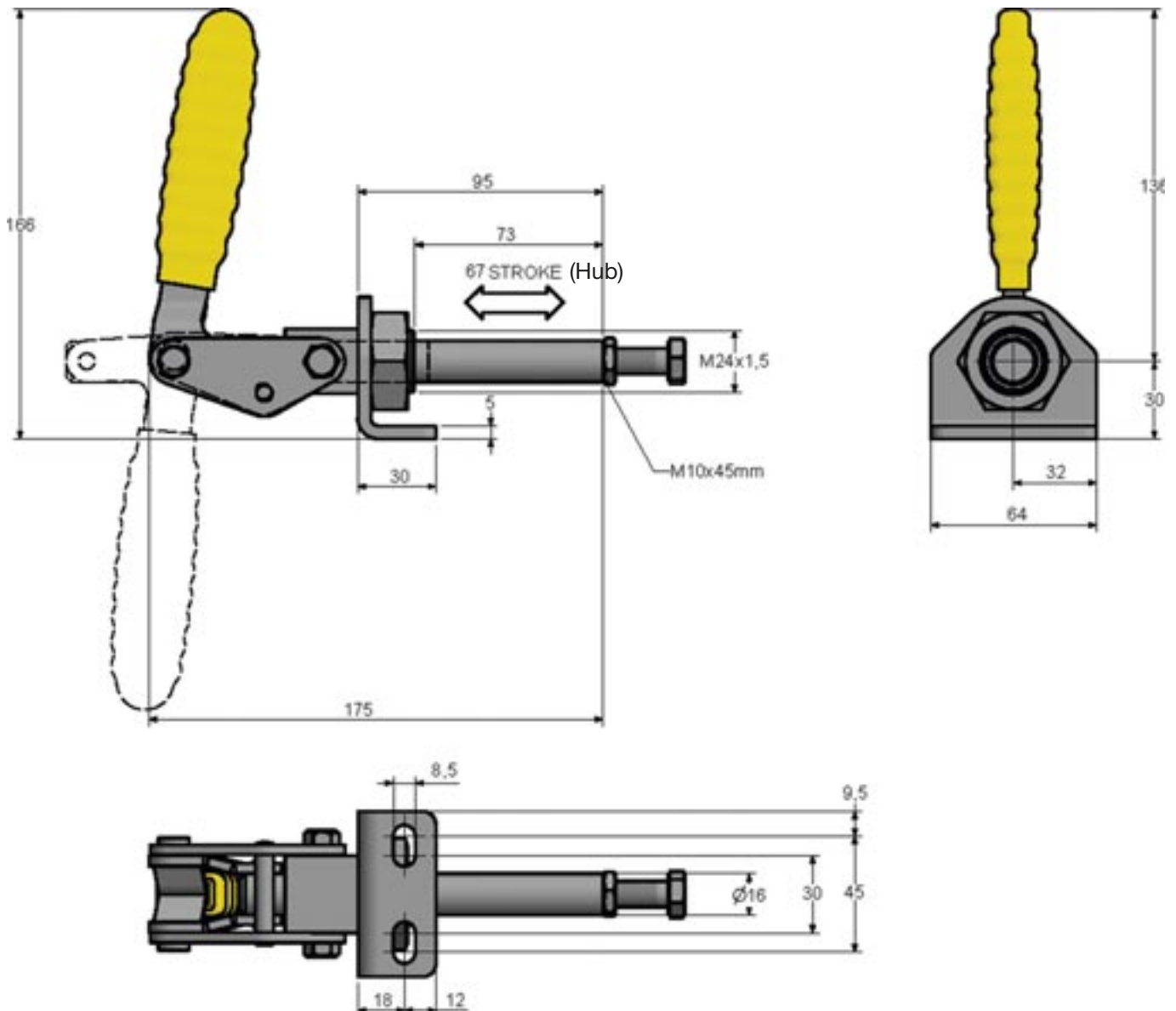

STÖßELWIRKUNG