

Material	Schwerer Stahl Gehärtete Buchsen
Oberfläche	verzinkt
Im Lieferumfang	Haken Befestigungsplatte
Max. Haltekraft	710 daN
Gewicht	0.72 kg
Hub	-
Spanndruck	430 daN

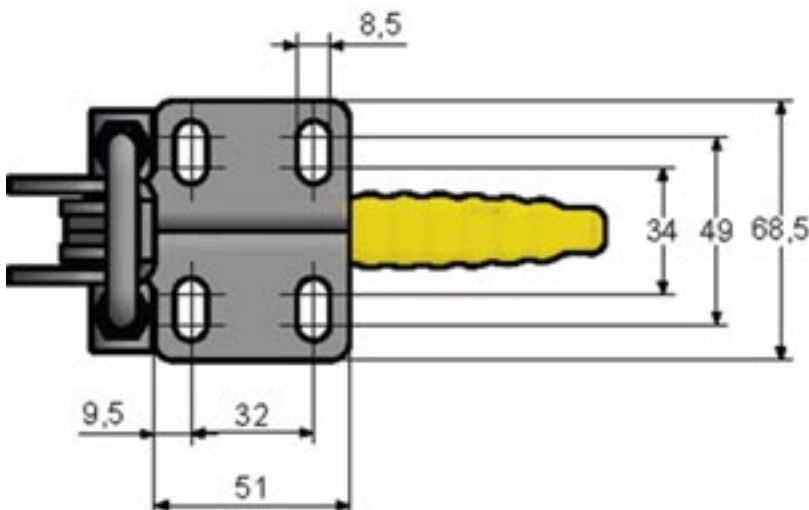
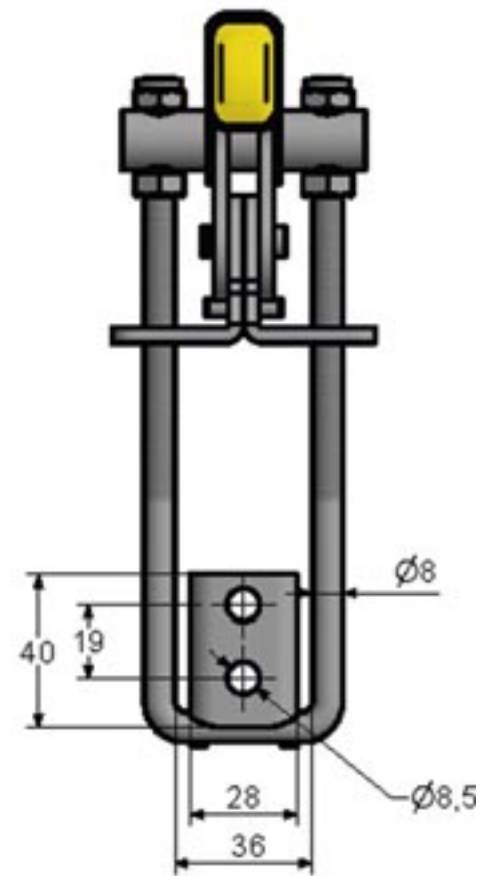
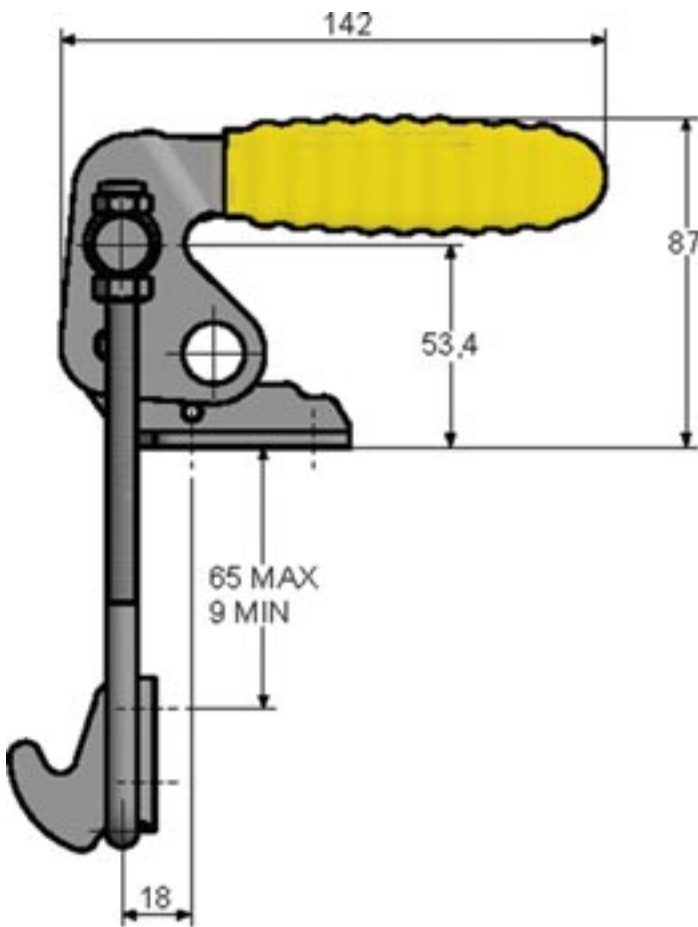

HAKENSPANNER